

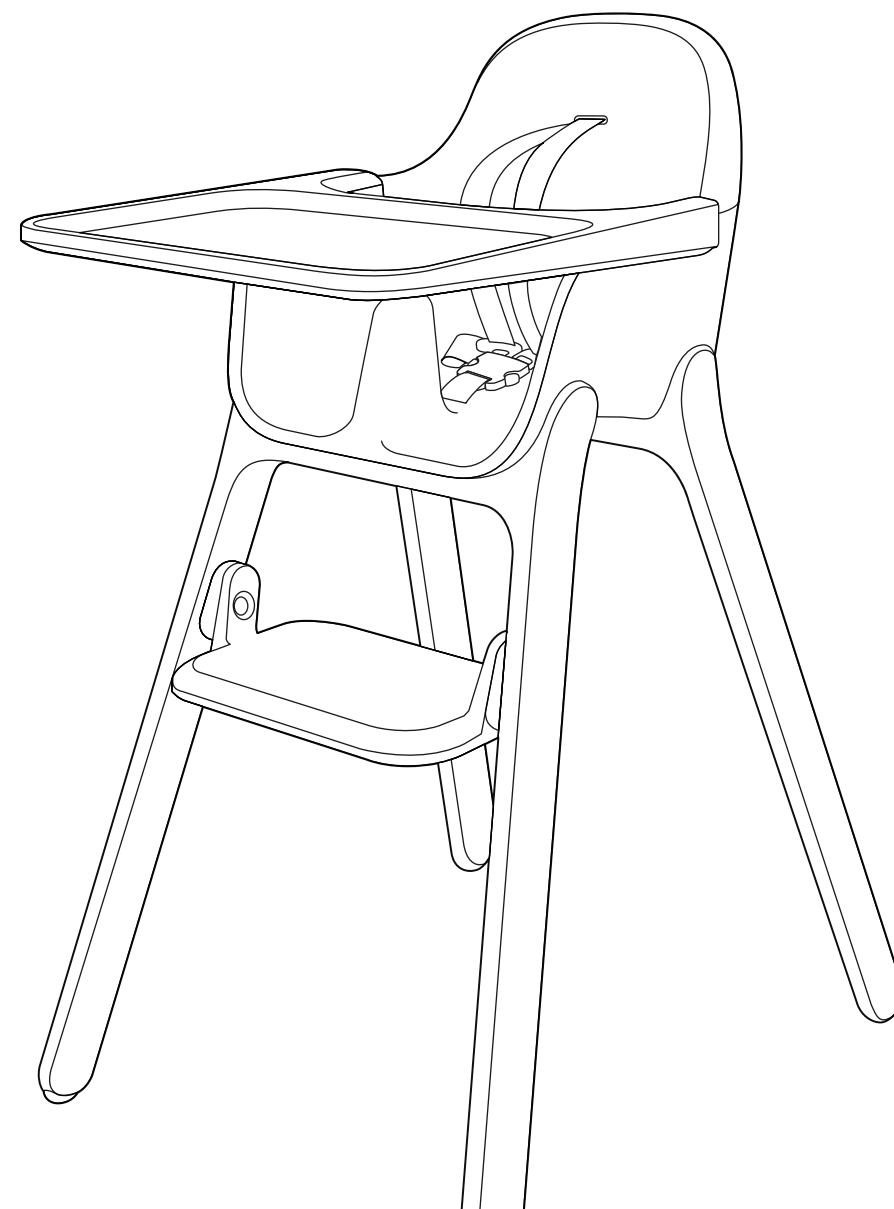

UPPAbaby®  
Ciro™



USA | UPPAbaby, 276 Weymouth Street, Rockland, MA 02370  
Canada | UPPAbaby Canada, 201 Wicksteed Avenue, Suite 2, Toronto, Ontario M4G 0B1  
uppababy.com | 1.844.823.3132

Model 1701-CIR-AU

All rights reserved. © 2023 UPPAbaby. UPPAbaby and all associated logos are trademarks. All product specifications are correct at time of print. UPPAbaby reserves the right to change anything at any time without prior notice. Color representation is as close as print processes allow. Not all colors available at all retailers. UBMAN173-V02



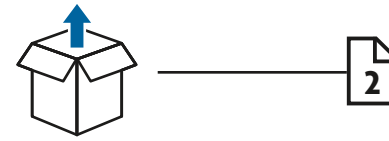

2

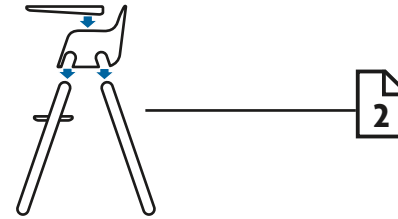

2

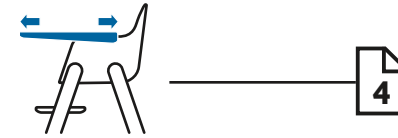

4

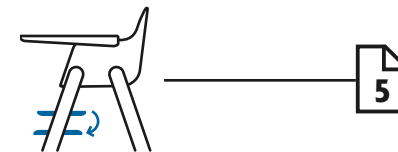

5



6



8

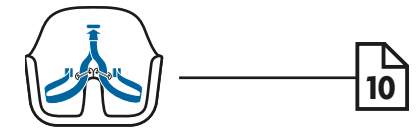

10

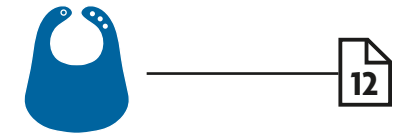

12



13



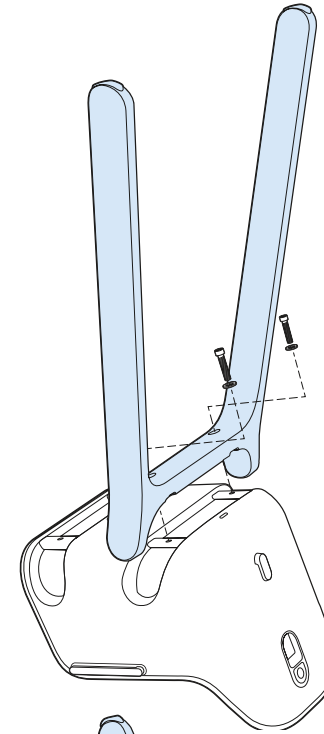
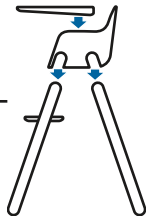
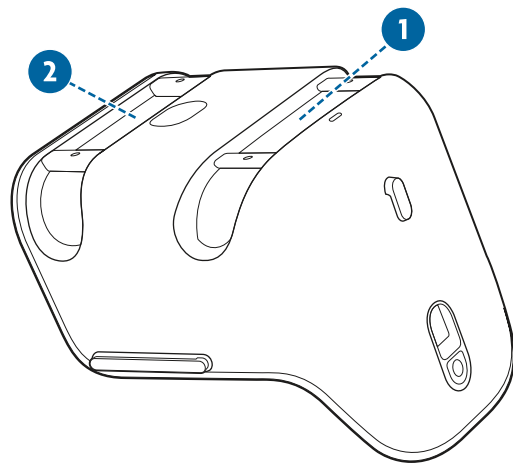
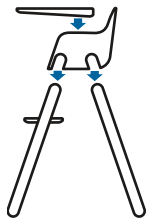
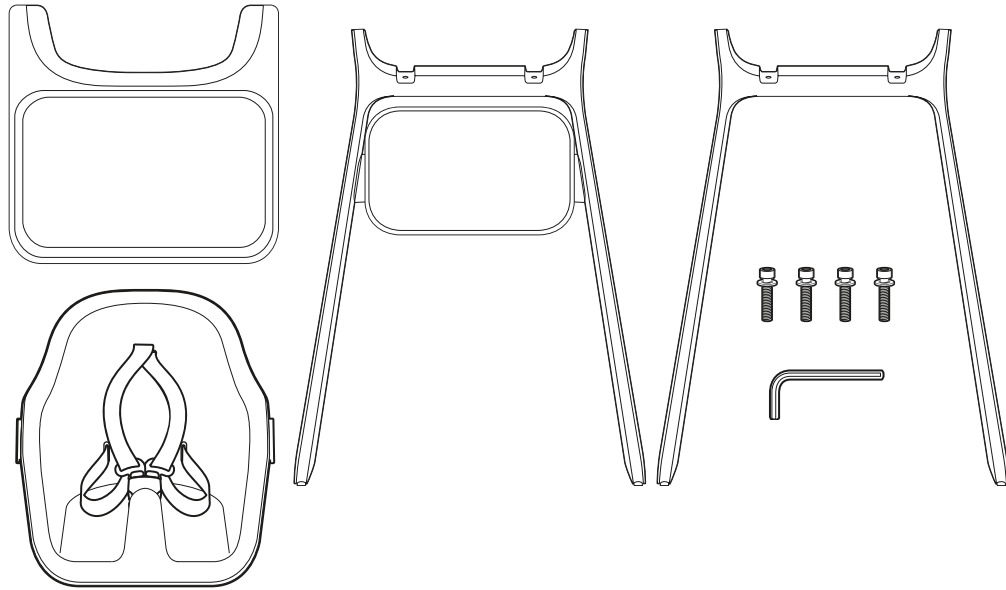
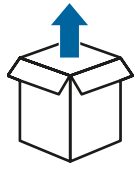

1

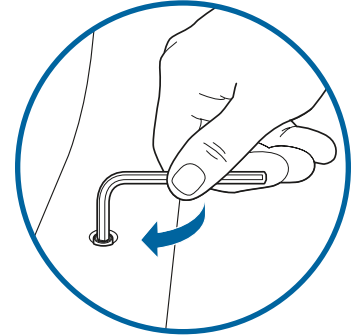

2

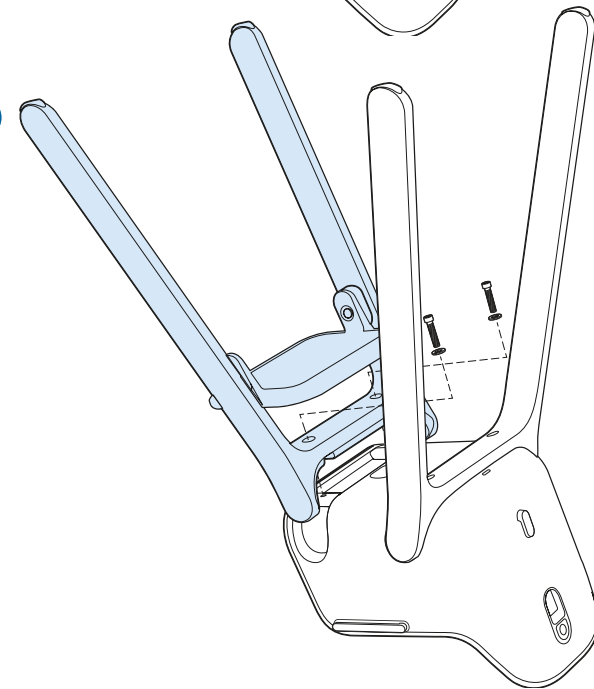

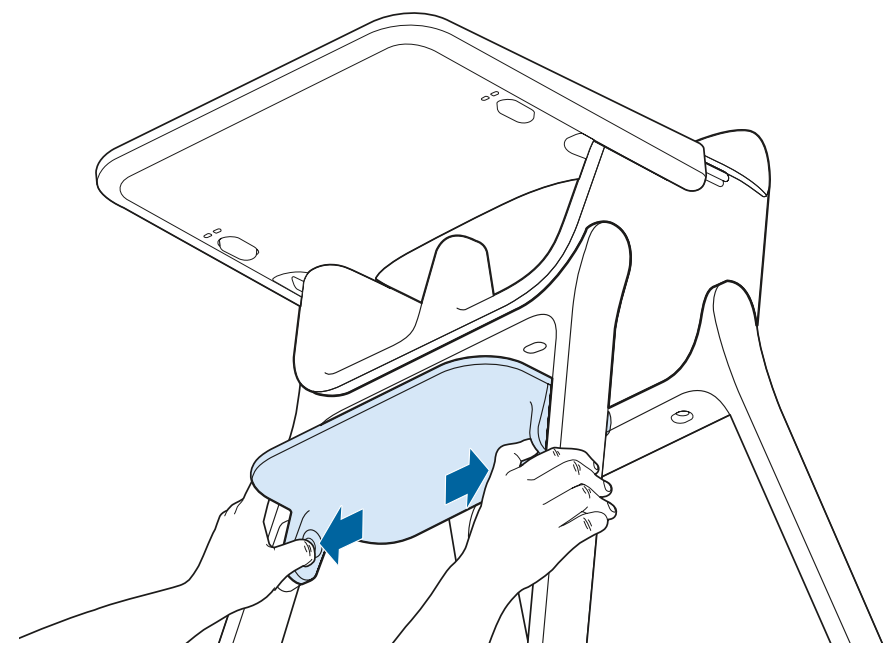
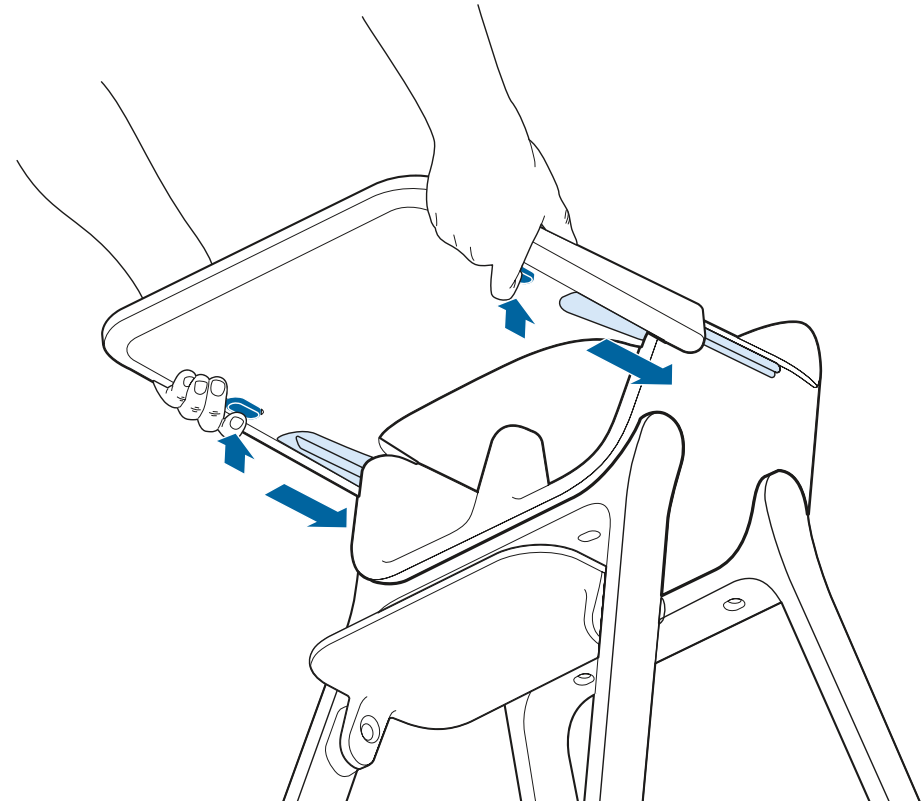
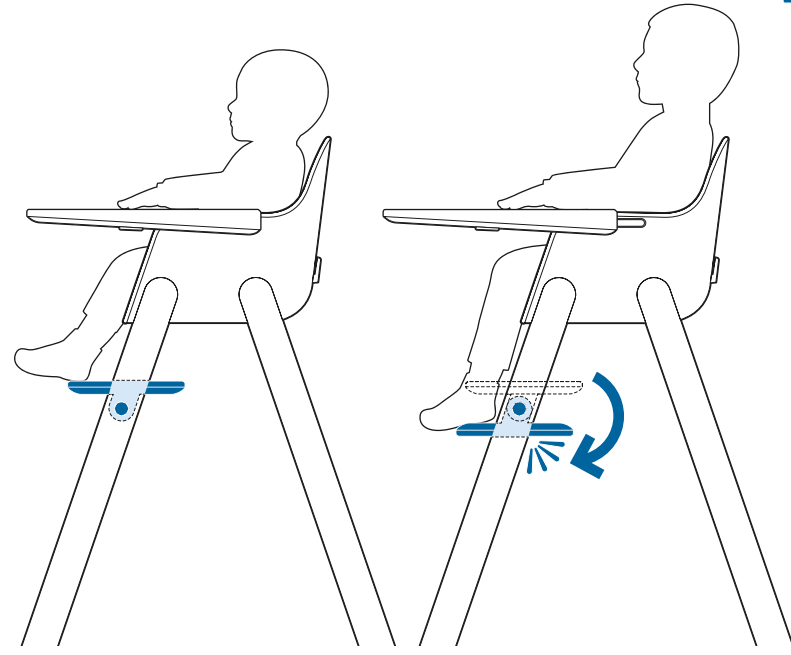
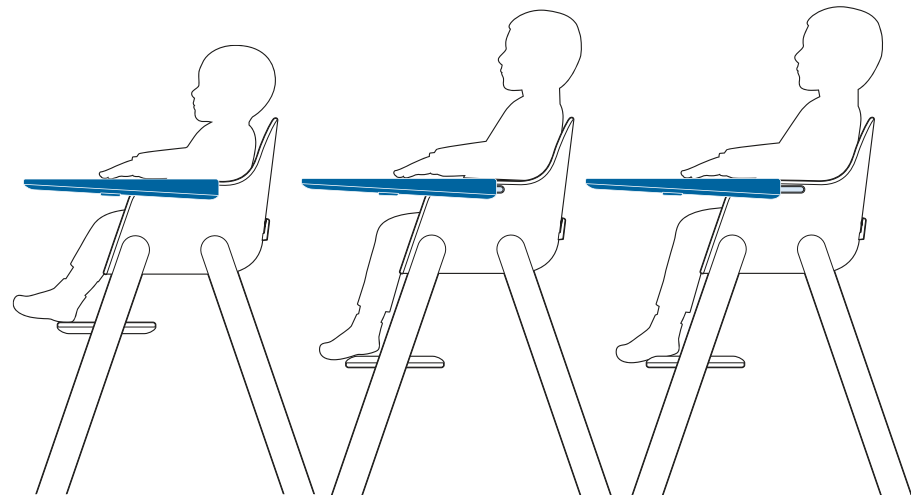

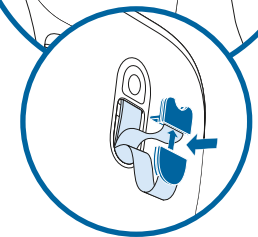
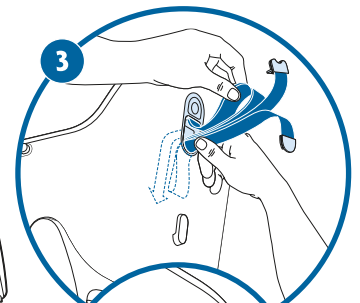
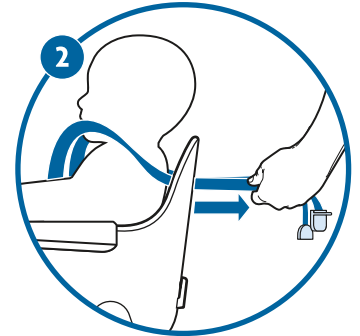
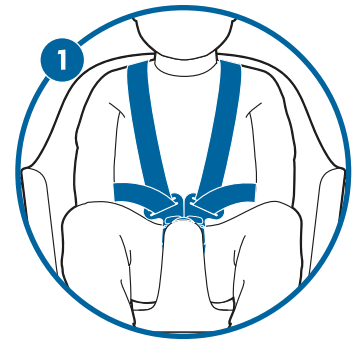
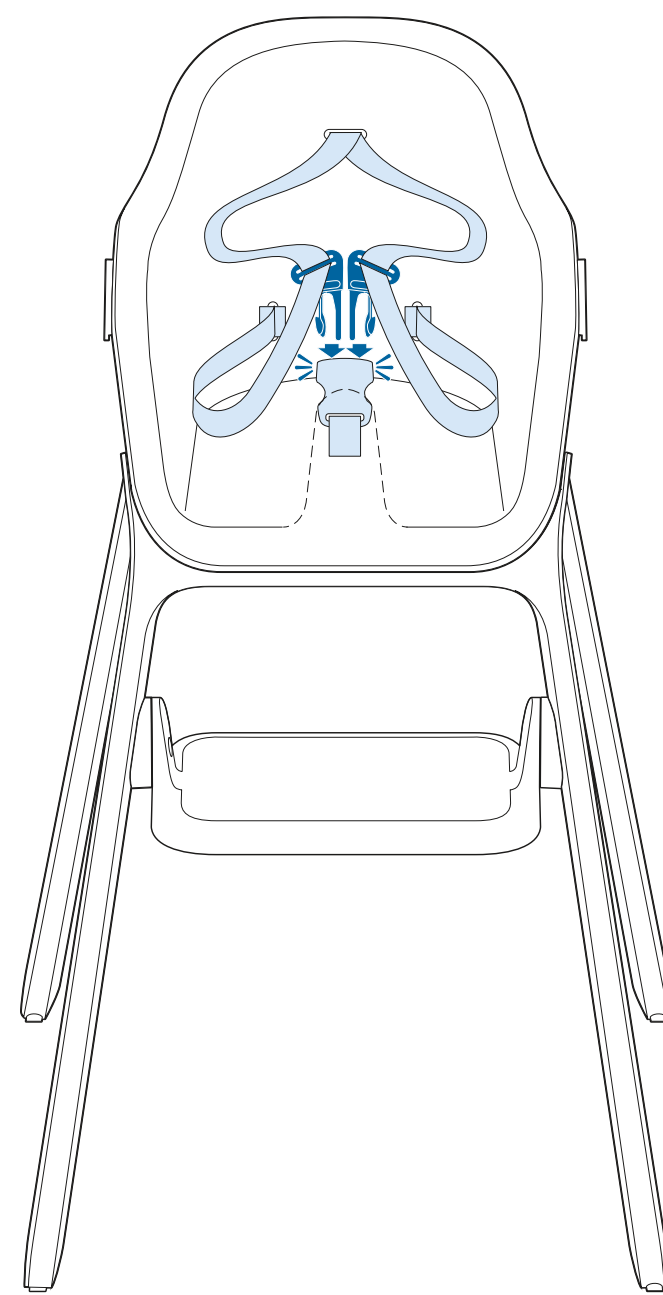
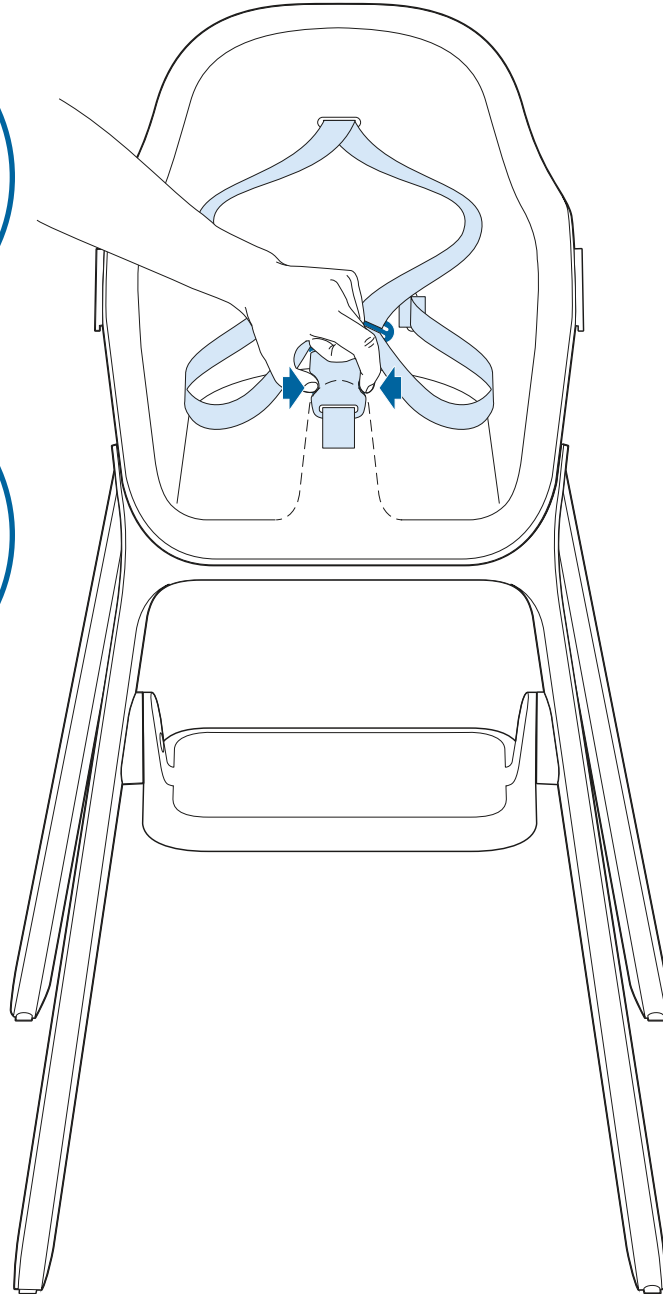
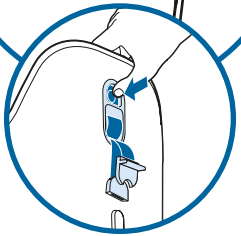
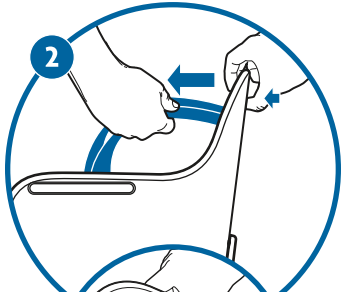
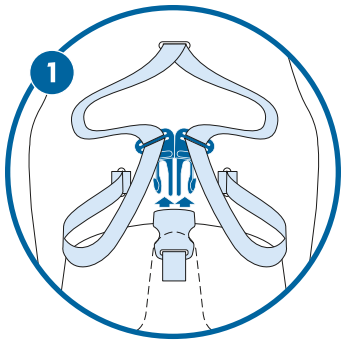
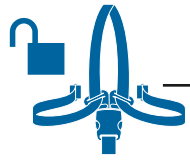

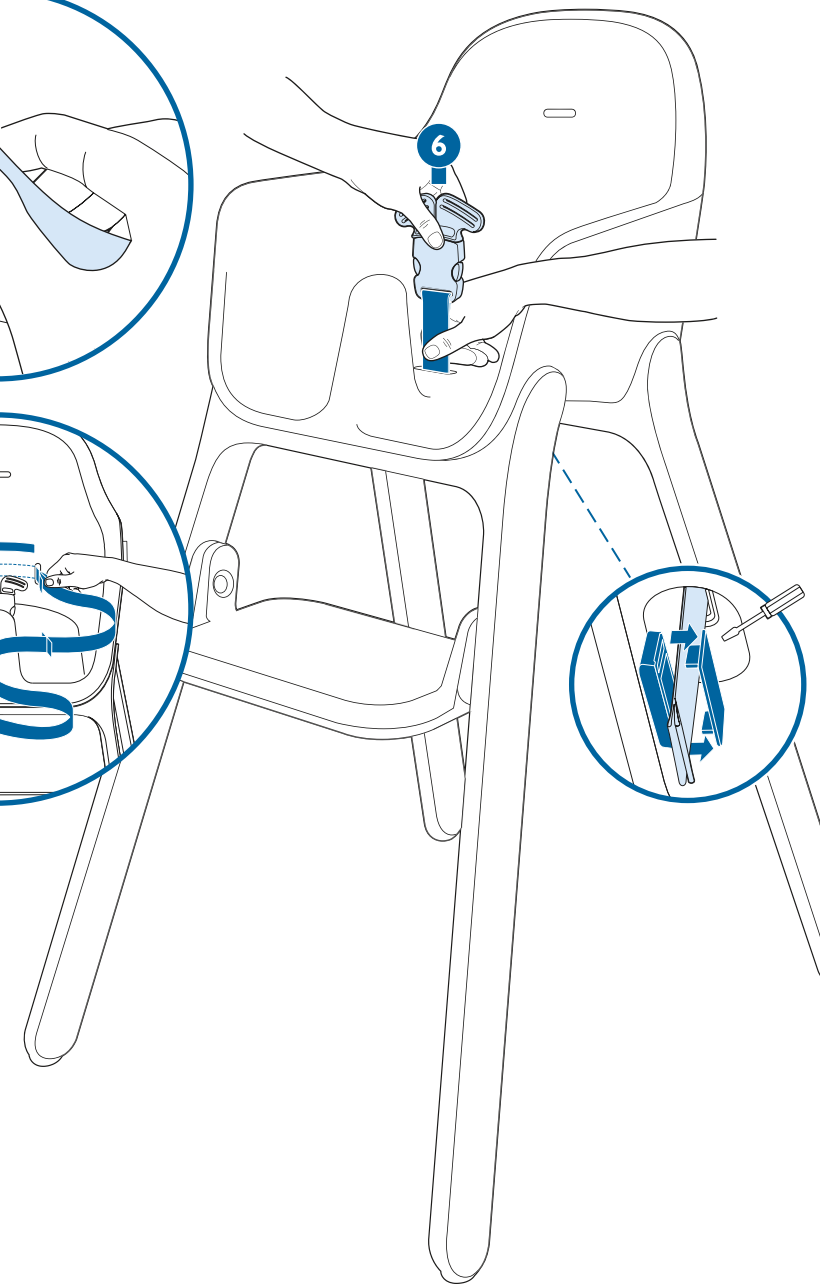
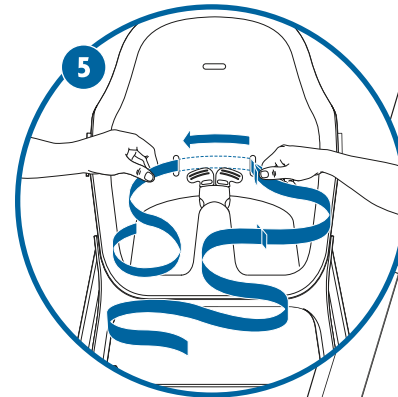
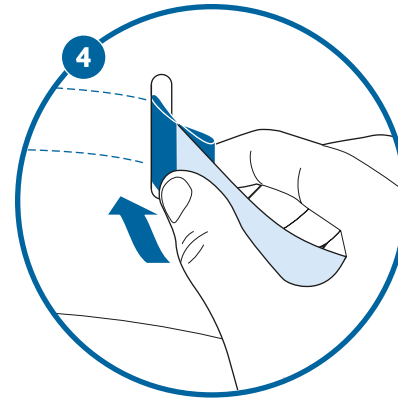
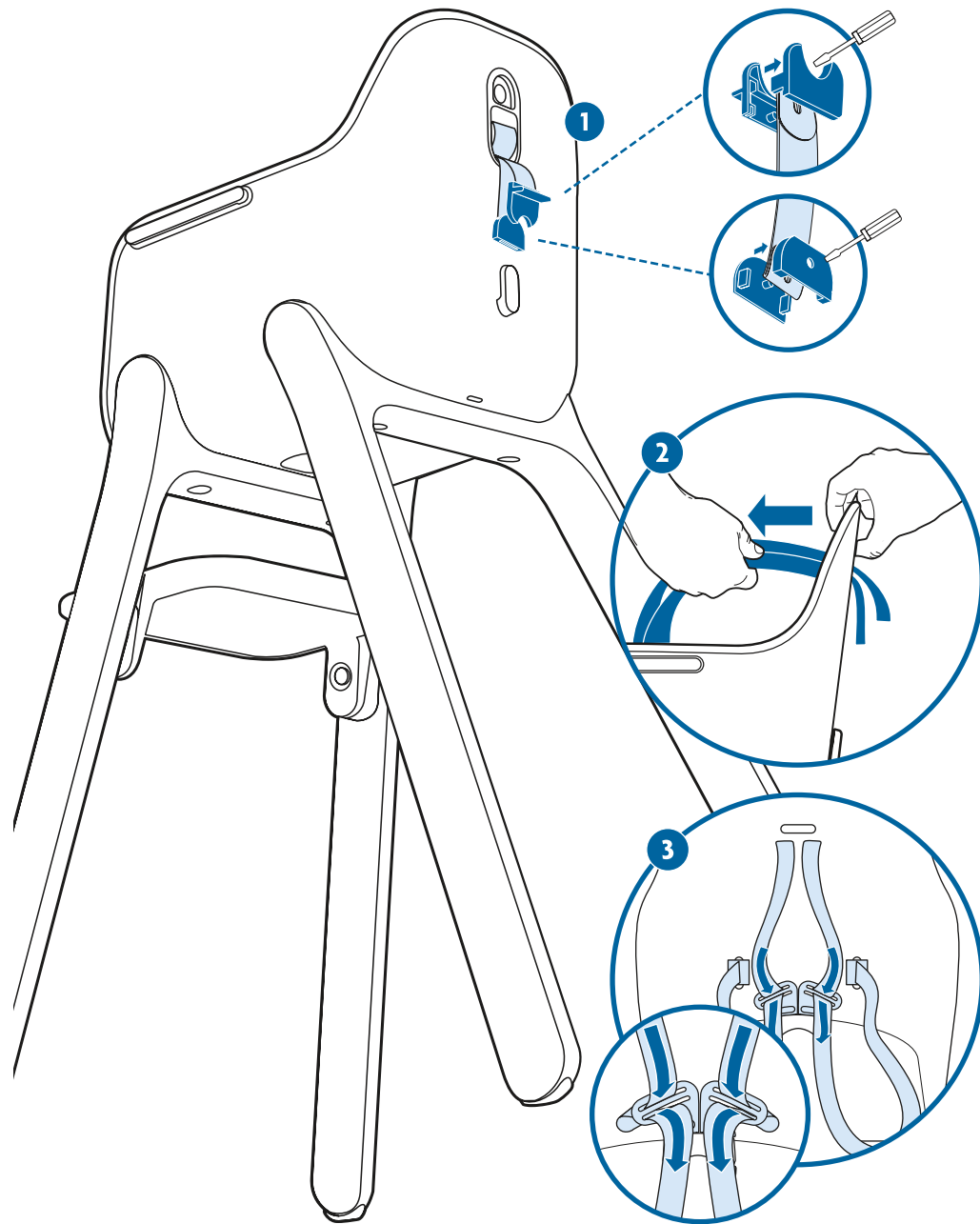
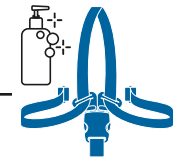
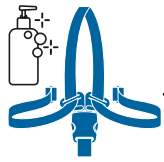

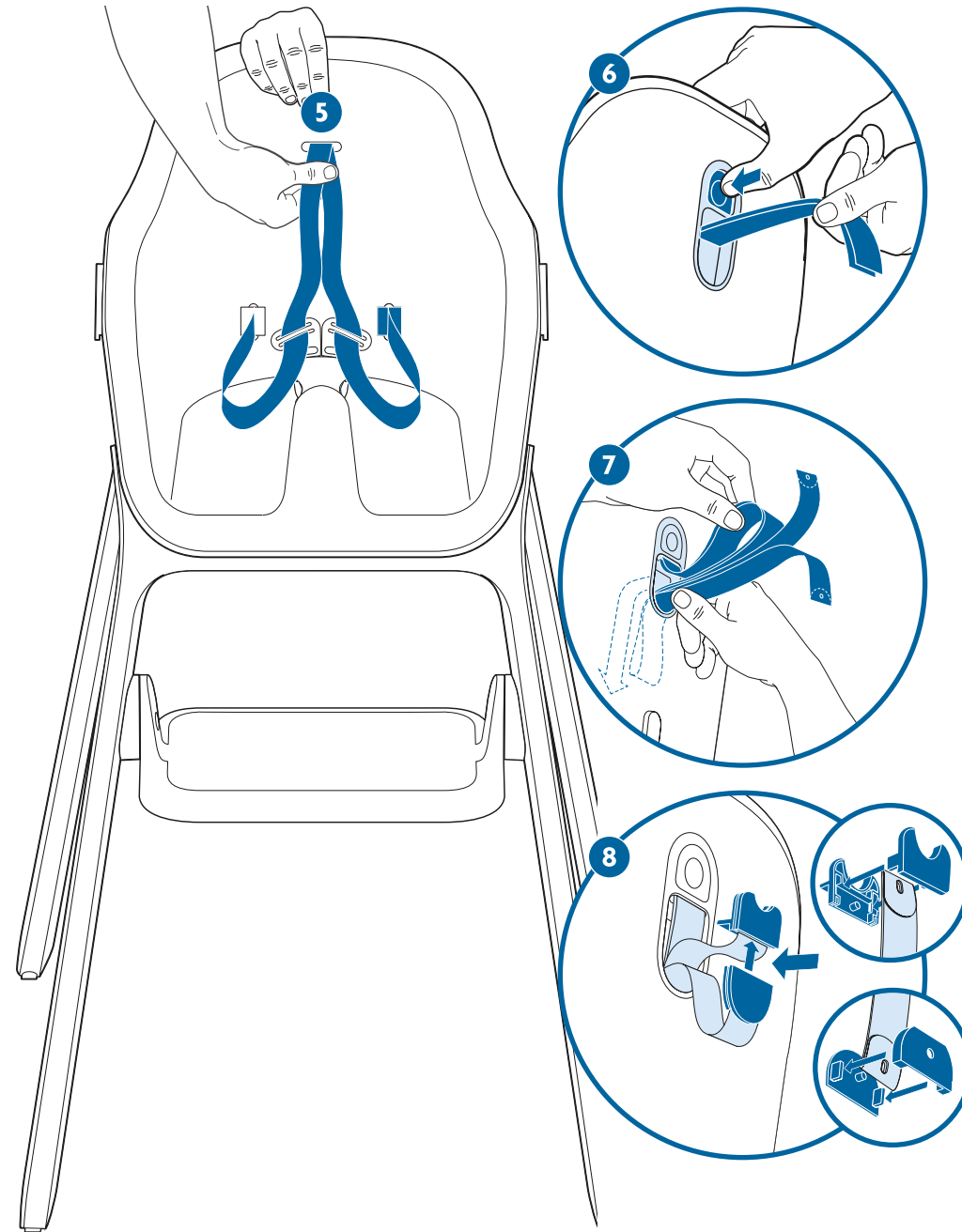
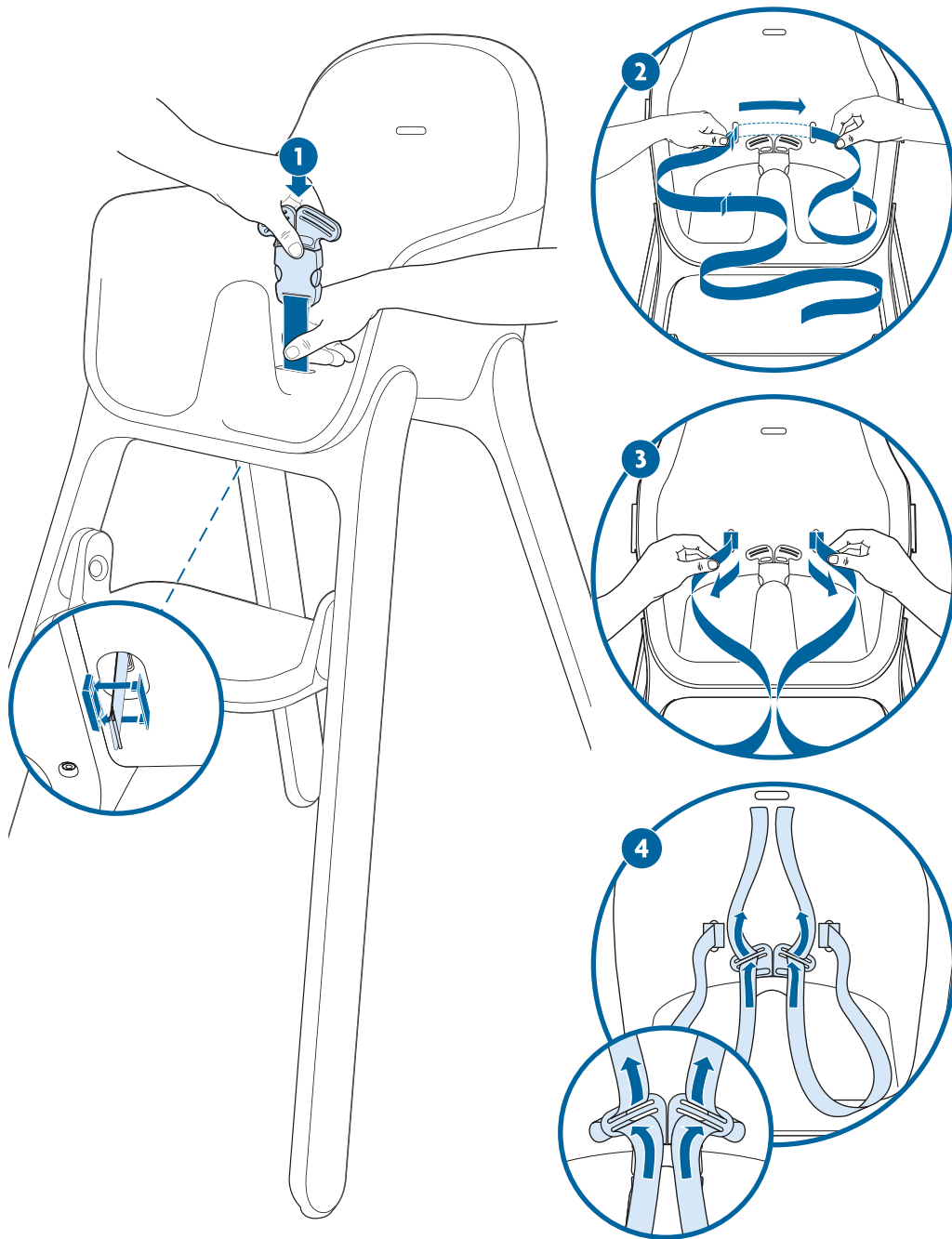
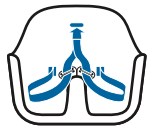

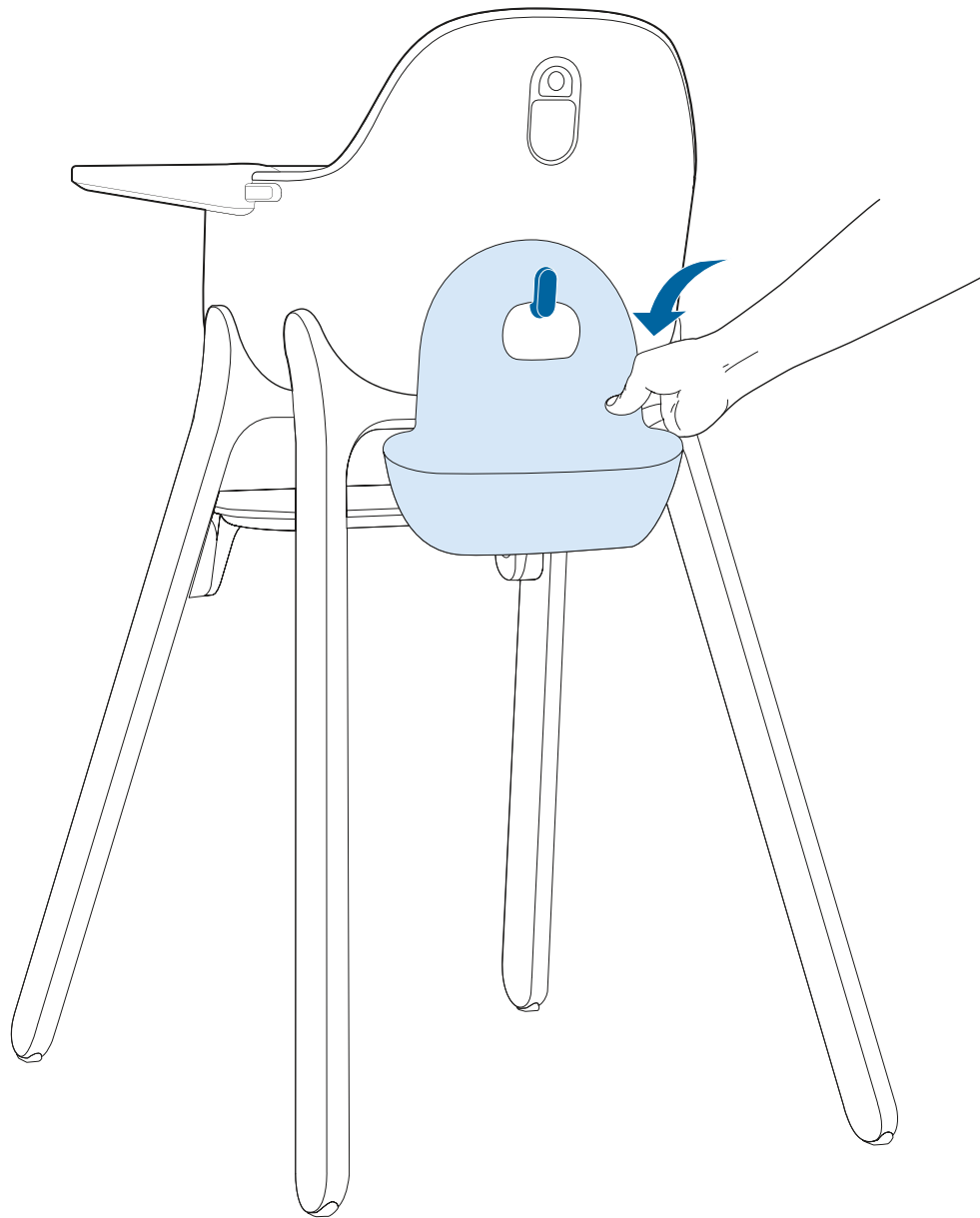

## IMPORTANT! READ CAREFULLY AND KEEP FOR FUTURE REFERENCE.

Failure to follow instructions properly may result in serious injury to your child.

### **⚠ WARNING**

FOLLOW THE MANUFACTURER'S INSTRUCTIONS.

DO NOT LEAVE CHILDREN UNATTENDED.

THE HARNESS MUST ALWAYS BE USED AND CORRECTLY FITTED—MOST INJURIES FROM HIGH CHAIRS ARE CAUSED BY FALLS.

POSITION THE HIGH CHAIR AWAY FROM SOLID STRUCTURES AND BENCHES TO AVOID INJURIES CAUSED BY FALLS AND BY ACCESS TO DANGEROUS ITEMS.

Product is intended for children able to sit up unaided and up to 3 years or a maximum weight of 15 kg.

DO NOT use product until the child can sit up unaided

It is recommended to wait until the child is at least 4 months old before using this product.

**FALLING HAZARD:** Prevent your child from climbing on the product.

**WARNING:** Always use the child restraint system.

Use only harness provided by UPPAbaby.

**WARNING:** Never leave the child unattended.

**WARNING:** Be aware of the risk of open fires and other sources of strong heat in the vicinity of the product.

**WARNING:** To reduce the risk of injury, position the high chair away from furniture, walls, hot surfaces and liquids, window covering cords, and electrical cords and position the high chair away from furniture when the chair is not being used at a table with a tray removed.

**WARNING:** Be aware of the risk of tilting when your child can push its feet against a table or any other structure.

**WARNING:** Only use the high chair on a flat, even and horizontal floor and do not elevate the high chair on any structure or table.

Regularly inspect high chair for defects

**WARNING:** Always check the security and the stability of the product before use.

**WARNING:** If the high chair is not working correctly, do not use and seek repair.

DO NOT use product if any part is broken, torn or missing

DO NOT use the product unless all components are correctly fitted and adjusted.

Complies with AS 4684 and EN 14988

## CLEANING

### SEAT, FOOTREST, AND LEGS

Wipe clean with a damp cloth

### TRAY

Dishwasher safe - Top rack ONLY with tray top facing down or hand wash and lay flat to dry with tray top facing down

### HARNESS AND BUCKLE

Hand wash or machine wash cold gentle cycle in garment bag. DO NOT bleach. Lay flat to dry.

## WARRANTY

### EXTENDED WARRANTY

UPPAbaby offers an Extended Warranty of one year for a total of three years on all strollers, bouncers, high chairs, playards and select accessories (Bassinet, RumbleSeat, Changing Station and PiggyBack).

To receive the additional one-year warranty, customers must register their product within three months of purchase and provide a valid receipt from an authorized retailer. It's our way of saying thank you!

Register your product at [uppababy.com/register](http://uppababy.com/register).

### LIMITED WARRANTY

Your UPPAbaby product is warranted to be free from manufacturing defects for a period of 2 years from the date of purchase under normal use and in compliance with the operating instructions.

This warranty is not transferable and extends only to the original retail purchaser and is only valid when supplied with proof of purchase from an authorized retailer. Proof of purchase must be retained for this warranty.

The warranty is valid only in the original country of purchase. This warranty is subject to the conditions set forth by country in which the items were purchased. Conditions may vary. UPPAbaby will not ship replacement or repair parts outside the country of purchase.

UPPAbaby will provide replacement parts or conduct repairs as determined fitting by the company. UPPAbaby reserves the right to exchange item with a replacement part. Some parts may be replaced with newer model parts as the item is improved over time.

This warranty does not cover:

- Defects caused by misuse or poor maintenance. (Please refer to the product instruction booklet for guidance on item use and maintenance).
- Damage caused by improper installation of UPPAbaby parts and/or accessories. (Please refer to product instruction booklet for guidance on item assembly and use).
- Damage caused by corrosion mold or rust due to poor maintenance, service or storage.
- Damage resulting from normal wear and tear.
- Damage or degradation caused by the sun, sweat, detergents, damp storage conditions or frequent washings.
- Repairs or modifications carried out by a third party.
- Product purchased from an unauthorized retailer. (Approved retailers are listed on our website [uppababy.com](http://uppababy.com)).
- Second owners and users other than the registrant.
- Damage resulting from airline shipping and handling.
- Products Involved in an accident.

UPPAbaby reserves the right to determine if warranty terms and conditions have been met.

For warranty service: In the US and CA please contact UPPAbaby Customer Experience (844) 823-3132 and visit [uppababy.com/contact](http://uppababy.com/contact) to send an email. Within the US, warranty conditions may differ from state to state.

Outside of the US and CA please contact your local distributor. Distributor information can be found at [uppababy.com/global-distributors](http://uppababy.com/global-distributors).

