

3 QUICK INSTALLATION GUIDE

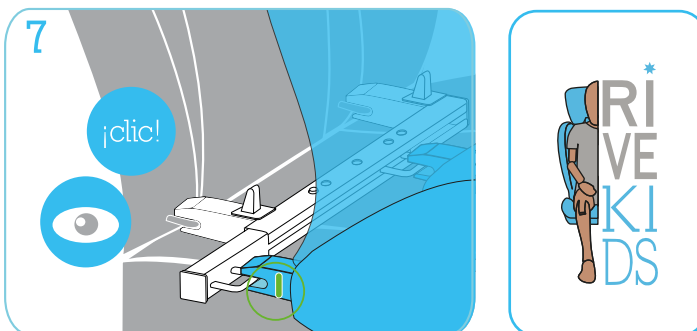
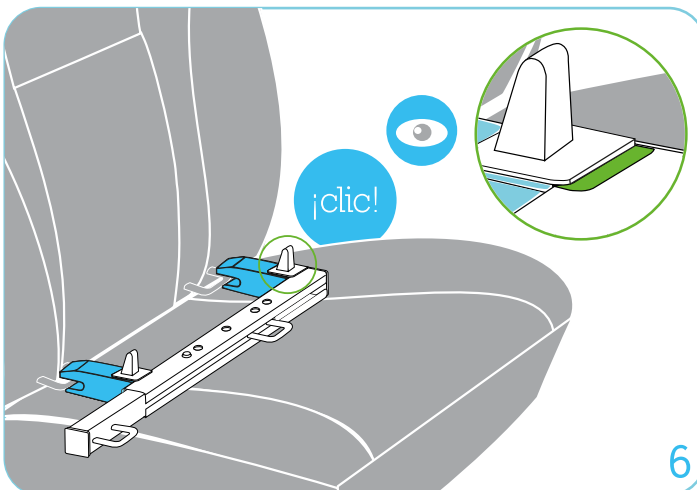
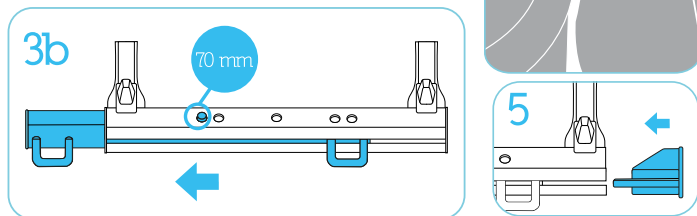
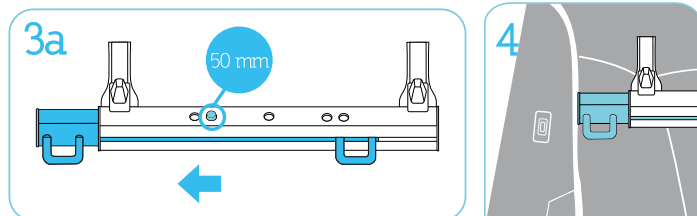
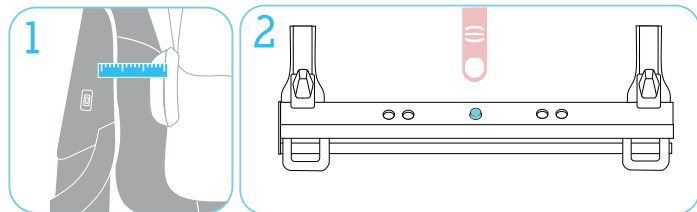

These instructions contain important information on your RiveMove device, so please read them carefully. The contents include:

1. WHAT YOU MUST KNOW...
 2. PARTS
 3. QUICK INSTALLATION GUIDE
 4. BEFORE USING THE PRODUCT
 5. CONTROL AND REQUIREMENTS
 6. USE INSIDE THE VEHICLE
 7. CONSERVATION AND DISPOSAL
 8. SAFETY INSTRUCTIONS
 9. INSTALLATION
 10. REMOVAL
- ANNEX: COMPATIBILITIES

Group 2/3



RiveMove is connected to the ISOFIX attachment points of the vehicle.



The RiveMove parts are recyclable.



If you have any further questions, please do not hesitate to get in touch with us.

RIVEKIDS TECHNOLOGY S.L.

C/ Monasterio de Yuste Nº 5A, Bajo 1
47017 Valladolid (Spain)

CONTACT

Tel.: +34 983 514 762
E-mail: info@rivekids.com
www.rivekids.com

RIVEKIDS
TECHNOLOGY



RIVEMOVE

“The true journey finishes how it began,
happily and innocently”

Instructions for use

Semi-universal product manufactured in Spain.



SAFETY



COMFORT



COMMITMENT

www.rivekids.com

1 WHAT YOU MUST KNOW...

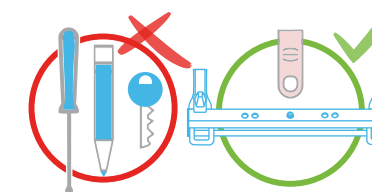

The slide and adjust clip (11) must always be pressed with the index finger; under no circumstances should a pen, screwdriver or any other object be used.

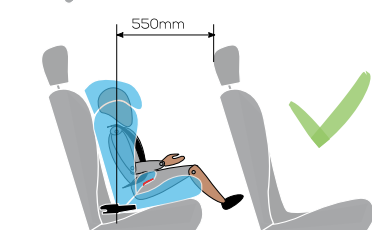

It is recommended to maximize this distance, which must be at least 550mm.

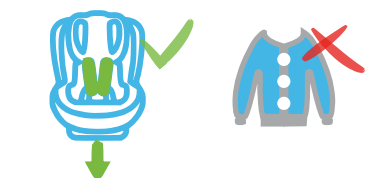

The CSR harness/belt must be fastened tightly. Pull firmly until there is no gap between the child and belt. Coats are not recommended when using CRS.

2 PARTS

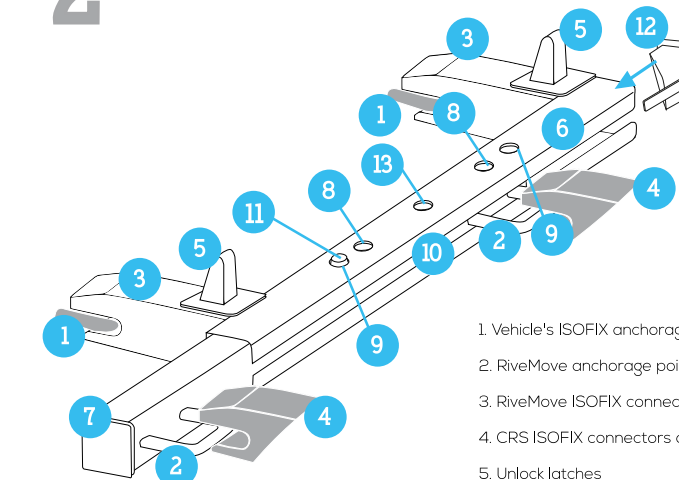

1. Vehicle's ISOFIX anchorage points
2. RiveMove anchorage points
3. RiveMove ISOFIX connectors
4. CRS ISOFIX connectors or similar
5. Unlock latches
6. Guide
7. Sliding bar
8. Position hole 50 mm
9. Position hole 70 mm
10. Scroll lane
11. Slide and adjust clip
12. Guide protectors
13. Nominal position

In the RiveMove box you will find: this instructions manual, one or two RiveMove units and one or two guide protectors (12) and a quality review process note which proves the correct functioning of your devices that have been individually verified by RiveKids Technology personnel, so that they may present minor imperfections in the decorative layer. There are two labels attached to your RiveMove that outline the most important steps to follow for correct installation.