



DUALFIX PRO

USER GUIDE



EN

BRITAX RÖMER Child Safety EMEA

www.britax-roemer.com | contact@britax.com

Contents

1	Symbol explanation.....	3
2	Safety.....	4
2.1	User Guide.....	4
2.2	Intended use.....	4
2.3	Misuse.....	4
2.4	Safety information.....	4
3	Settings.....	5
3.1	Adjust headrest.....	5
3.2	Use the insert for newborn babies.....	5
3.3	Adjusting the seat angle.....	6
3.4	Change direction of travel.....	6
4	Use in the vehicle.....	7
4.1	Secure child seat.....	7
4.2	Loosen child seat.....	9
5	Buckling in and unbuckling.....	10
5.1	Boarding and exit function.....	10
5.2	Buckle child in.....	11
5.3	Check before every use.....	11
5.4	Unbuckle child.....	12
6	Cleaning and maintenance.....	13
6.1	Cover.....	13
6.2	Shoulder pads.....	15
6.3	Harness buckle.....	16
6.4	Troubleshooting.....	16
7	Storage and disposal.....	18
7.1	Storage.....	18
7.2	Disposal.....	18
8	Contact.....	19

1 Symbol explanation

Warning signs

Warning signs are used in this user guide in order to advise of potential danger situations. The warning signs inform you about the following items:

- Level of danger,
- Type and source of danger,
- Consequences if disregarded,
- Measures to prevent danger.

Warning signs are shown as follows:

WARNING

Type and source of danger

Consequences if disregarded

- ▶ Measures to prevent danger

Level of danger	Meaning
DANGER!	Highlights dangerous situations which, if not avoided, lead to serious injuries or death.
WARNING!	Indicates a dangerous situation which, if not avoided, can lead to serious injuries or death.
CAUTION!	Indicates a dangerous situation which, if not avoided, can lead to slight to moderate injuries.
NOTE	Indicates actions that can lead to damage.

Signs and symbols

-  Highlights important information for you.

Specific actions

- ▶ ...

Action

1. Demands action from you.
2. Defined sequence of actions.
3. ...

Result of action

- ✓ There is where you will find the result of a sequence of actions.

2 Safety

2.1 User Guide

This user guide is a component of the product and contributes to its safe use. Non-compliance may lead to serious or even fatal injuries. If there are uncertainties, do not use the product and immediately contact your retailer.

- ▶ Read the User Guide.

2.2 Intended use

This product has been designed, tested and approved corresponding to the requirements of UN R129/03.

This product is designed for securing a child in a vehicle.

The product is approved for the following details:

Designation	Value
Body height	Rear-facing seat: 40 – 105 cm
	 You must use the insert for newborn babies for body sizes up to a maximum of 60 cm.
	Forward-facing seat: From 15 months and 76 – 105 cm
Body weight	≤ 19 kg

This approval is invalidated if you make any modifications to this product. Changes may only be made by the manufacturer. The stickers on the product are an important component of the product.

- ▶ Do not make any changes to the product.
- ▶ Do not remove any stickers from the product.

2.3 Misuse

- ▶ Do not use the product as a toy.
- ▶ Do not use the product as a chair outside the vehicle, not even to test.
- ▶ Only secure the child seat with fastening points described in this User Guide.
- ▶ Do not fasten the product either with a 2-point seat belt or a 3-point seat belt.
- ▶ Ensure that the product is not trapped between hard objects (car door, seat rails, etc.).
- ▶ Keep product away from moisture, wet conditions, liquids, dust and salt spray.
- ▶ Do not lean heavy objects on the product.

- ▶ Never lubricate or oil parts of the product.
- ▶ Sensitive car seat covers may be damaged. Use the Britax Römer child seat base. These are available separately.

2.4 Safety information

Risk of injury from damaged child seat

In the event of an accident at a collision speed of more than 10 km/h, the child seat may be damaged without the damage being immediately visible. Serious injuries may result from another accident.

- ▶ Replace the product after an accident.
- ▶ Have a damaged product inspected (even if it has fallen onto the ground).
- ▶ Regularly check all the important parts for damage.
- ▶ Ensure that all mechanical components work properly.

Risk of burns from hot components

Components of the product may become hot in direct sunlight. Children's skin is sensitive and maybe harmed as a result.

- ▶ Protect the product against intensive direct sunlight when not in use.

Risk of injury during use

The temperature in a vehicle can rise dangerously quickly. In addition, it is dangerous to leave the vehicle on the side facing the street.

- ▶ Never leave the child unsupervised in the vehicle.
- ▶ Only secure and remove the child seat from the foot-path-side.

Risk of injury from unsecured objects

In the case of an emergency stop or accident, unsecured objects or people may cause injury to other occupants in the vehicle.

- ▶ Only fasten the product as described in these operating instructions.
- ▶ Secure backrests of the vehicle find (e.g. engage foldable rear).
- ▶ Fasten or remove all heavy or sharp-edged objects in the vehicle (e.g. on the parcel shelf).
- ▶ Ensure that everyone in the vehicle has their seatbelts fastened.
- ▶ Ensure that the product is always secured when it is in the vehicle, even if no child is being transported.

3 Settings

3.1 Adjust headrest

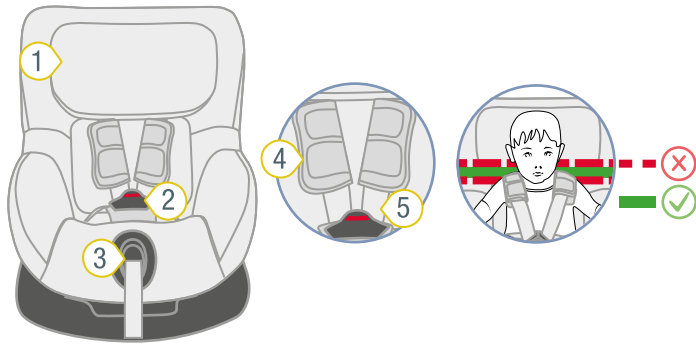

- ① Headrest
- ② Harness buckle
- ③ Adjustment button
- ④ Shoulder pads
- ⑤ Shoulder strap
- ⑥ release button

1. Check that the headrest 1 is adjusted correctly.

- ① If the shoulder straps are at or slightly above the shoulder height of the child, the headrest is positioned correctly.
 - ▶ If the headrest is not positioned correctly, perform the following steps.

2. To loosen the belt, press the adjustment button 3 and pull both shoulder straps 5 forwards at the same time.

- ① The shoulder pads are **not** connected to the shoulder straps. If you pull on the shoulder pads, the belt is **not** loosened. Only pull on the shoulder straps.

3. Keep the release button 6 pressed and slide the headrest 1 to the correct shoulder height.

4. Check that the headrest 1 is locked correctly in place by pushing the headrest 1 down.

- ✓ Headrest 1 is adjusted correctly.
- ✓ Headrest 1 is locked in place.

3.2 Use the insert for newborn babies

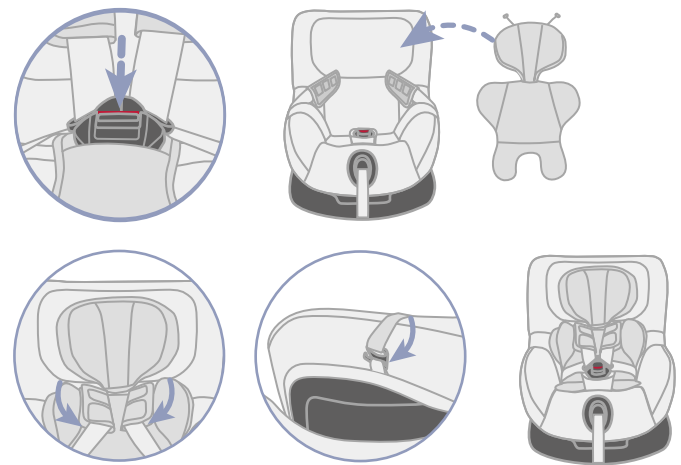
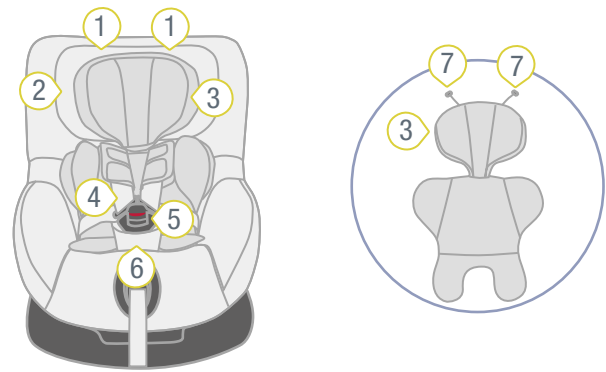

- ① Loops
- ② Headrest
- ③ Insert for newborn babies
- ④ Shoulder straps
- ⑤ Harness buckle
- ⑥ Padded crotch
- ⑦ Plastic hooks

- ① You must use the insert for newborn babies for body sizes up to a maximum of 60 cm.

1. Open the harness buckle 5 by pressing the red button.
2. Place the insert for newborn babies 3 into the child seat.
3. Place both shoulder straps 4 over the seat reducer.
4. Hang the two plastic hooks 7 in the loops 1 on the cover of the headrest 1.
5. Pass the harness buckle 5 and the padded crotch 6 through the recesses in the lower section of the insert for newborn babies.

4 Use in the vehicle

4.1 Secure child seat

4.1.1 Select seat

1. Select a suitable seat.

- Car seats with i-Size approval are suitable.

i In rare cases, the child seat on car seats with i-Size approval can only be adjusted within limits.

- Suitable car seats with ISOFIX installation bracket, which have been tested and approved by us. You can find these in our model list at www.britax-roemer.com.
- Only car seats arranged in the direction of travel are approved for use.

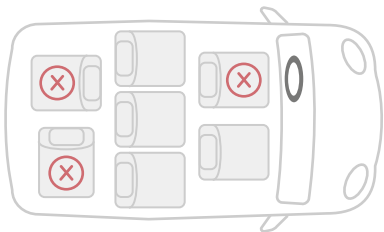

2. Note and observe the vehicle handbook.

i Britax Römer recommends positioning the car seats as follows.

When using on the front seat:

- ▶ Slide the front seat as far back as possible.

When using on the rear seat:

- ▶ Slide the back seat as far back as possible.
- ▶ Slide the front seat as far forwards as possible.

4.1.2 Attach insertion aids

i The insertion aids simplify connecting the ISOFIX locking arms of the child seat to the ISOFIX installation bracket on the car seat. Some vehicles already have integrated insertion aids. Check whether your vehicle already has the required insertion aids. If the vehicle does not have them, Britax Römer recommends using the insertion aids. These are included in the scope of delivery of the child seat.

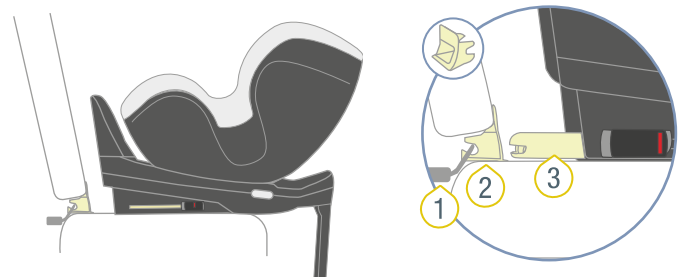

- ① ISOFIX installation
- ② Insertion aid
- ③ ISOFIX locking arms bracket

▶ Clamp the two insertion aids 2, with the cut-out facing up, to the ISOFIX installation bracket 1 of the car seat.

i For car seats with foldable backrests, the insertion aids 2 must be removed before folding the backrest.

4.1.3 Position child seat

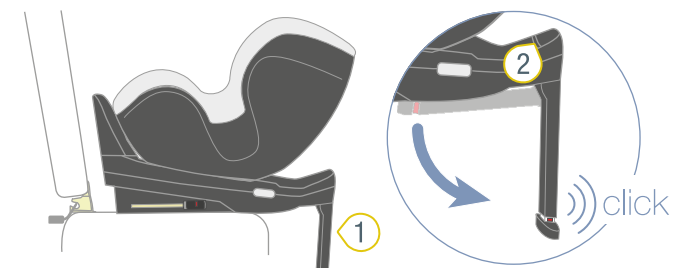

- ① Support leg
- ② Rotation indicator

1. Fold the support leg 1 completely away from the child seat.

- ✓ The support leg 1 audibly locks in place.
- ✓ The red rotation indicator 2 is no longer visible.

- Place the child seat on the selected car seat.
- Fold the support leg 1 completely away from the child seat.

4.1.4 Fastening the ISOFIX

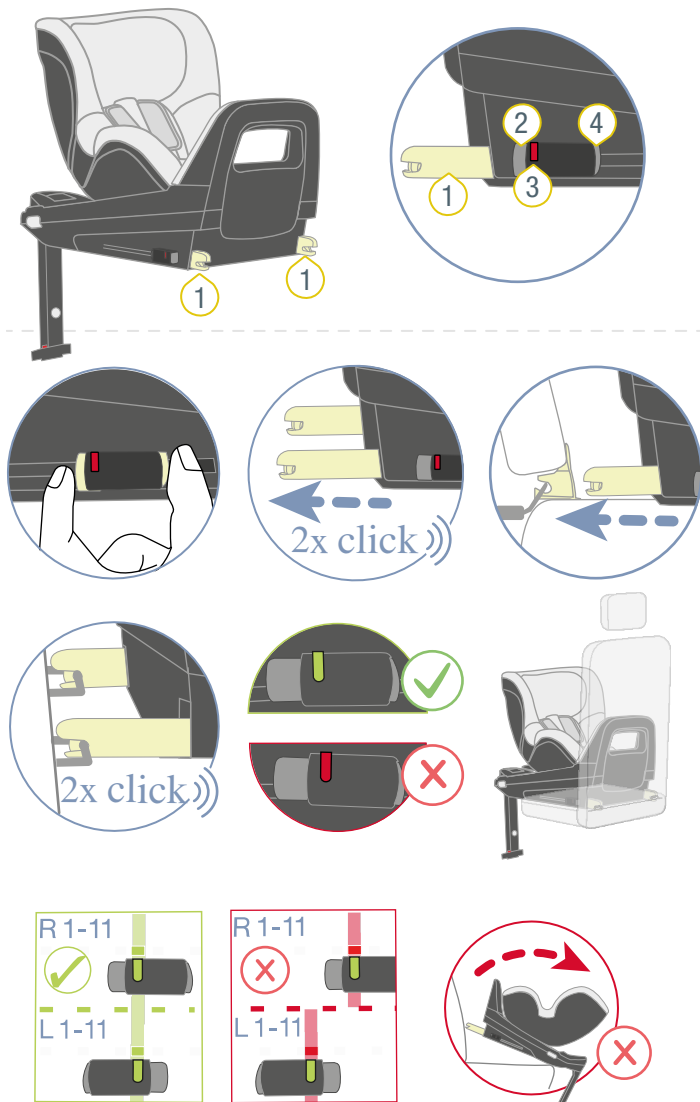

- ① ISOFIX locking arms ③ ISOFIX indicator
- ② Release button ④ Fastening button

- Press the locking button 4 and the release button 2 together and slide the ISOFIX locking arm 1 out as far as possible.
 - ✓ The ISOFIX locking arm 1 audibly locks in place.
- Slide out the second ISOFIX locking arm 1 as far as possible, as well.
 - ✓ The second ISOFIX locking arm 1 audibly locks in place.
 - ✓ Both ISOFIX locking arms 1 are extended to the maximum.
- Connect the ISOFIX locking arms 1 to the ISOFIX installation bracket on the car seat.
 - ✓ Both ISOFIX locking arms 1 audibly lock in place.
 - ✓ Both ISOFIX indicators 3 are green.

⚠ WARNING Risk of injury from unsecured child seat. Make sure that both ISOFIX locking arms are fully locked in place. Both ISOFIX indicators must be green.

- Clamp the ISOFIX connection by forcefully pushing the child seat into the backrest of the car seat.

INFO Clamping the child seat into the car seat reduces the amount of horizontal movement of the child seat. The smaller the possible movement, the better the child will be protected.

- Increase the tension of the ISOFIX connection by forcefully pushing forwards on the base station.

INFO We recommend pushing the base station left and right.

- Check that the ISOFIX locking arms 1 are both retracted to the same distance.

i The positions of the ISOFIX locking arms are shown on the product using numbers. These numbers are located above the ISOFIX indicators. Both ISOFIX indicators must show the same number.

- Check that the ISOFIX locking arms 1 are connected to the ISOFIX installation brackets on both sides by pulling at the child seat.

✓ If neither of the ISOFIX locking arms 1 comes loose, they are both connected to the vehicle.

4.1.5 Setting support leg

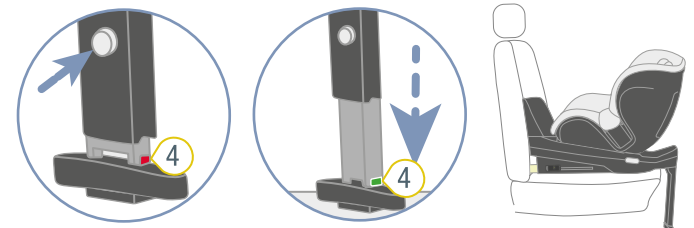
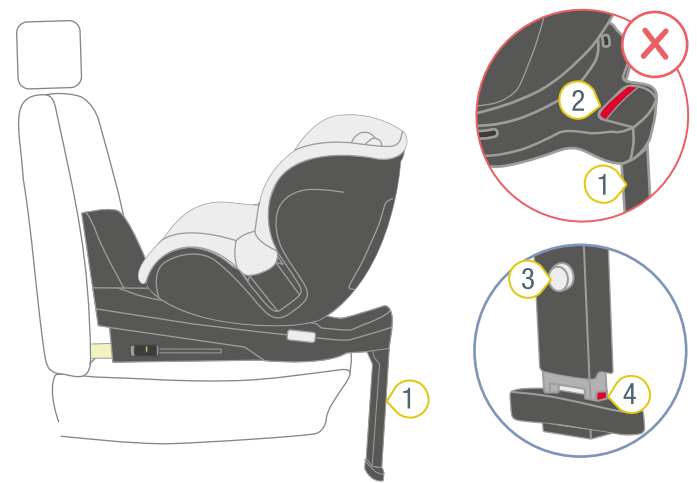

- ① Support leg ③ Adjustment button
- ② Rotation indicator ④ Support indicator

- Make sure that the support leg 1 is still folded out.
 - ✓ The red rotation indicator 2 is not visible.
- Keep holding the adjustment button 3 depressed.
- Extend the support leg 1 to the floor of the vehicle.
- Release the adjustment button 3.

- ✓ The adjustment button **3** audibly locks in place.
 - ✓ The protection indicator **4** is green.
 - ✓ The bottom of the child seat is on the seat of the car seat.
- ⚠ WARNING** Risk of injury if the support leg is not stable. **Never** place objects underneath the support leg. Make sure that the support leg is standing stably on the floor of the vehicle.
5. Make sure that the support leg **1** **does not** raise the bottom of the child seat from the surface of the car seat.

3. Release the adjustment button **1**.
- ✓ The support leg **2** is fully retracted.
4. Press the locking button **5** and the release button **4** together and slide the ISOFIX locking arm **3** back into the bottom section of the seat.
 5. Slide the second ISOFIX locking arm **3** back into the bottom section of the seat as well.
- ✓ Both ISOFIX locking arms **3** are protected against damage.

4.2 Loosen child seat

⚠ WARNING

Risk of injury from unsecured objects

In the case of an emergency stop or accident, the unsecured child seat may cause injury to other occupants in the vehicle.

- ▶ Ensure that the child seat product is always secured when it is in the vehicle, even if no child is being transported.

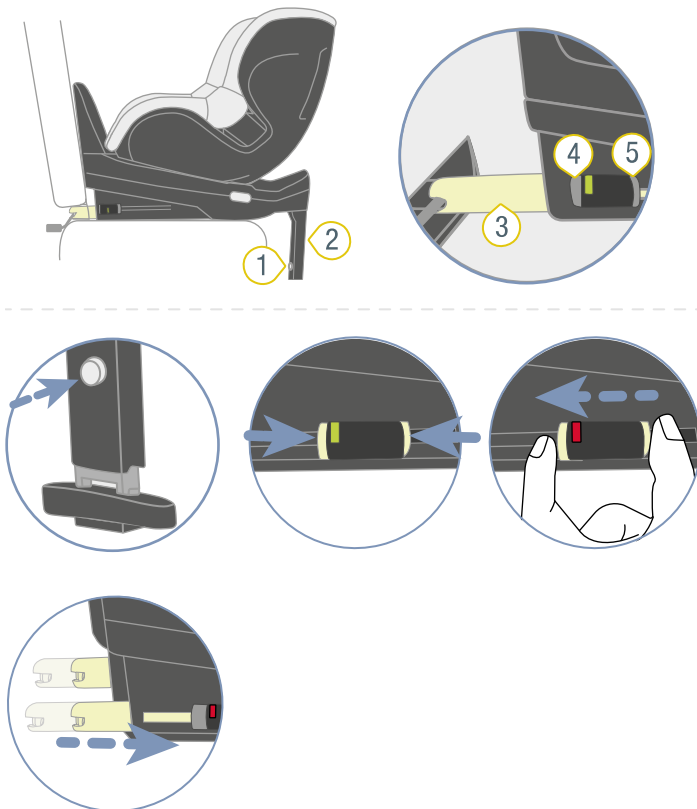

- ① Adjustment button
- ② Support leg
- ③ ISOFIX locking arms
- ④ Release button
- ⑤ Fastening button

1. Keep holding the adjustment button **1** depressed.
2. Slide the lower section of the support leg **2** into the upper section.

5 Buckling in and unbuckling

5.1 Boarding and exit function

⚠ WARNING

Risk of injury from front airbag

Airbags are designed to protect adults. The use of a front airbag when a seat is facing backwards can lead to serious or fatal injuries.

- ▶ Disable front airbag.
- ▶ **Never** use the seat facing backwards with an active front airbag.
- ▶ Note and observe the instructions in the vehicle handbook.

⚠ WARNING

Risk of injury if facing in the wrong direction

The alignment of the seat is critical for the safety of the child. If used incorrectly, even just braking can lead to serious or even fatal injuries.

- ▶ **Do not** use a front-facing child seat if your child is smaller than 76 cm or younger than 15 months.
- ▶ Britax Römer recommends use the child seat facing backwards for as long as possible.
- ▶ Before each car journey, ensure that the rotatable seat of the child seat is locked in place.

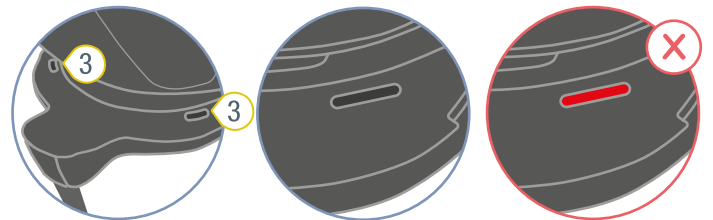
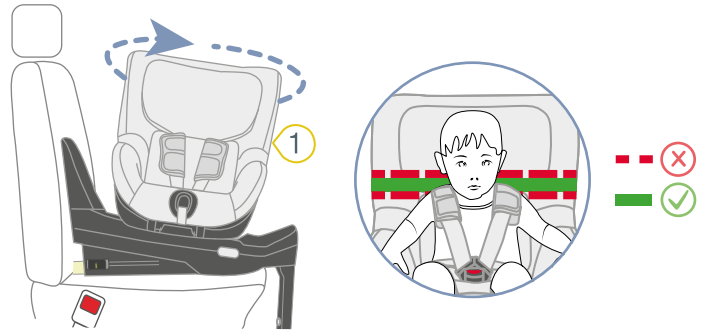

- ① Seat
- ② Rotary button
- ③ Rotation indicator

1. Press the rotary button **2** and simultaneously turn the seat **1** towards the car door.
2. Secure the child (see "Buckle child in", page 11).
3. Secure the seat **1** by turning it back.
 - ✓ The seat **1** audibly locks in place.
 - ✓ Both rotation indicators **3** are black.

⚠ WARNING Risk of injury from unsecured seat. Make sure that the seat is fully locked in place by pulling at it. Check the colour of the two rotation indicators. They must both be black.

5.2 Buckle child in

⚠ WARNING

Risk of injury from front airbag

Airbags are designed to protect adults. The use of a front airbag when a seat is facing backwards can lead to serious or fatal injuries.

- ▶ Disable front airbag.
- ▶ **Never** use the seat facing backwards with an active front airbag.
- ▶ Note and observe the instructions in the vehicle handbook.

⚠ WARNING

Risk of injury from slack straps

Slack straps are areas of the seat belt that lie loosely against the child's body. Slack straps have a negative impact on the protective function.

- ▶ Ensure that the straps are tight and not twisted.
- ▶ The child should not wear thick clothing under the belt.

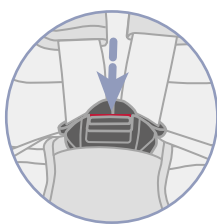
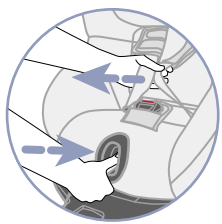
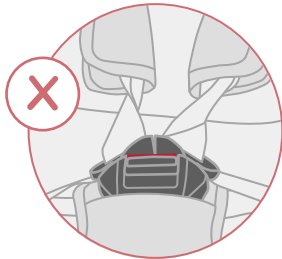
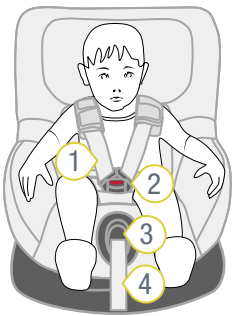

- ① Shoulder straps
- ② Harness buckle
- ③ Adjustment button
- ④ Adjustment belt

1. To loosen the belt, press the adjustment button **3** and pull both shoulder straps **1** forwards at the same time.
2. Open the harness buckle **2** by pressing the red button.
3. Place the harness buckle **2** at the front.
4. Never leave the child unsupervised in the seat.
5. Place the shoulder straps **1** over the child's shoulders.

⚠ **WARNING** Risk of injury if child is secured incorrectly. Make sure that the shoulder straps are not twisted or reversed.

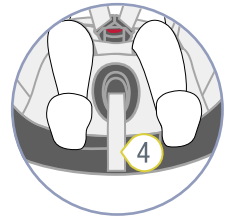
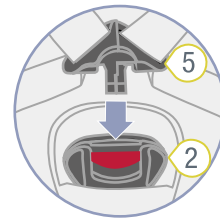
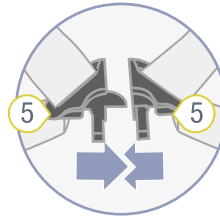

- ② Harness buckle
- ④ Adjustment belt
- ⑤ Buckle tongues

6. Bring the two buckle tongues **5** together.
7. Insert the joined buckle tongues **5** into the harness buckle **2**.
- ✓ The buckle tongues **5** audibly lock in place.
8. Pull at the adjustment belt **4** until the shoulder straps **1** are tight to the child's body.

⚠ **WARNING** Risk of injury to the abdomen (soft area in the stomach). Ensure that the hip straps are positioned as low as possible over your child's hips.

5.3 Check before every use

To protect your child, check the following points before each car journey.

1. Both ISOFIX locking arms are locked into the ISOFIX installation brackets.
2. Both ISOFIX locking arms are extended the same distance.
3. Both ISOFIX indicators are green.
4. The support leg is stable on the floor of the car.
5. The red indicator of the support leg is no longer visible.
6. The protection indicator on the support leg is green.
7. The seat audibly locks.
8. Both rotation indicators of the seat are black.
9. The straps are tight to the child's body without restricting the child.
10. The headrest is correctly adjusted.
11. The shoulder pads are in the right position on the child.
12. The straps are **not** twisted and **not** reversed.
13. If using the seat facing backwards, the front airbag is disabled.
14. The child seat is used as intended in respect of the age and size of the child (see "Intended use", page 4).

⚠ WARNING

Risk of injury due to omitted checks.

During the journey, the child may try to unbuckle the belt or loosen the child seat. If the child is not secured in the child seat, this can lead to serious or even fatal injuries.

If the child or the child seat is not fastened:

- ▶ Immediately stop the vehicle as soon as the traffic situation allows.
- ▶ Make sure that the child seat is secured.
- ▶ Ensure that the child is buckled in.

i For the wellbeing of your child, on long journeys Britax Römer recommends taking regular breaks. Give your child the opportunity to move.

5.4 Unbuckle child

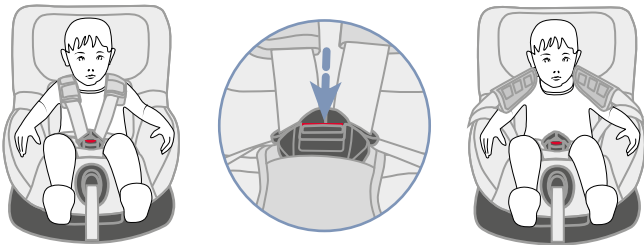

1. Open the harness buckle by pressing the red button.
2. Take the child out of the child seat.

6 Cleaning and maintenance

6.1 Cover

6.1.1 Remove cover from insert for newborn babies

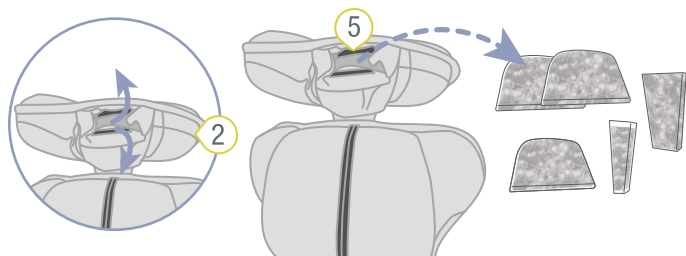
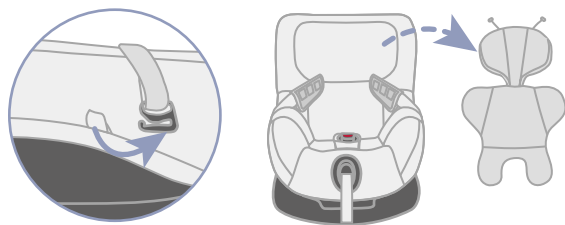
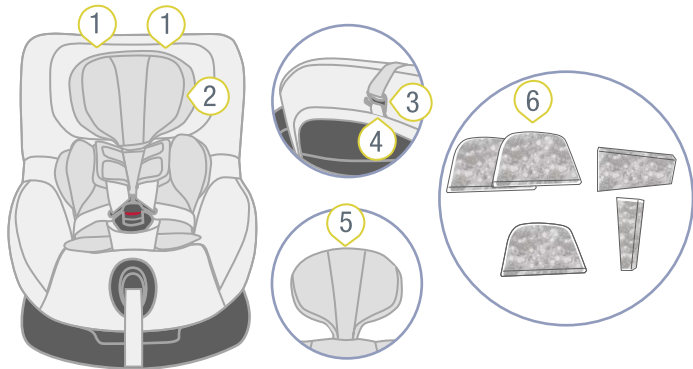

- ① headrest
- ② Insert for newborn babies
- ③ Hooks
- ④ Loops
- ⑤ Velcro
- ⑥ Foam parts

1. Remove the two hooks **3** from the loops **4** in the cover of the headrest **1**.
2. Undo the Velcro **5** on the headrest of the insert for newborn babies **2**.
3. Remove the foam sections **6**.

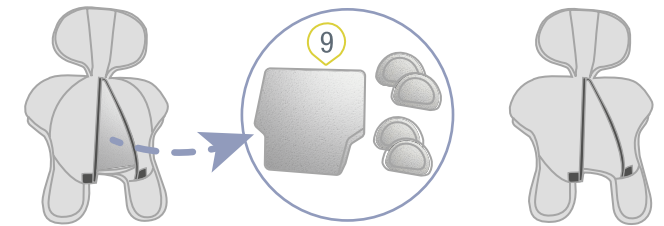
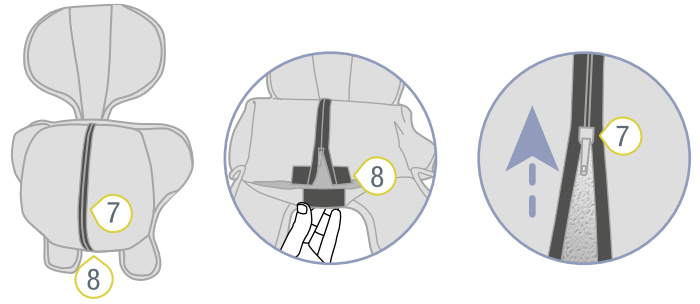

- ⑦ Zip
- ⑧ Velcro
- ⑨ Foam and styrofoam

4. Undo the Velcro **8** and the zip **7** on the lower section of the insert for newborn babies **2**.
5. Remove the foam **9** and the styrofoam sections **9**.

6.1.2 Remove cover from the headrest

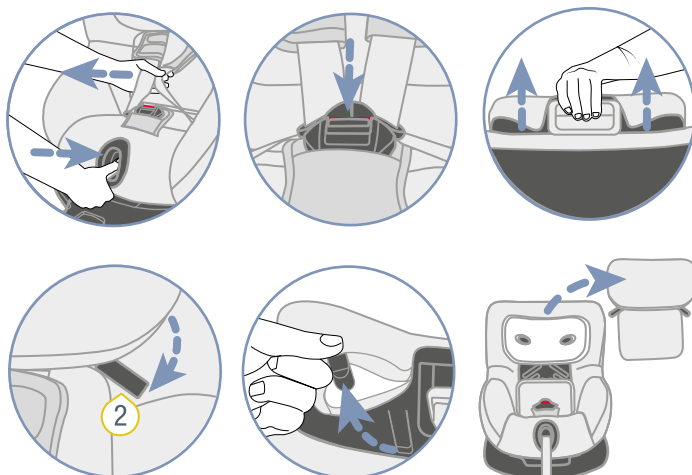
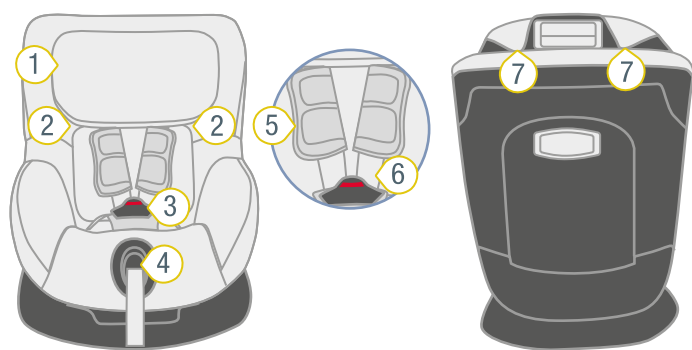

- ① headrest
- ② Rubber loops
- ③ Harness buckle
- ④ Adjustment button
- ⑤ Shoulder pads
- ⑥ Shoulder strap
- ⑦ Hooks

1. To loosen the belt, press the adjustment button 4 and pull both shoulder straps 6 forwards at the same time.
 - ① The shoulder pads are **not** connected to the shoulder straps. If you pull on the shoulder pads, the belt is **not** loosened. Only pull on the shoulder straps.
2. Open the harness buckle 3 by pressing the red button.
3. Adjust the head rest 1 to the highest position (see "Adjust headrest", page 5).
4. Loosen the rubber loops 2 on the bottom edge of the headrest.
5. Remove the hooks 7 at the top edge of the headrest.
6. Remove the cover.

6.1.3 Remove cover from the seat

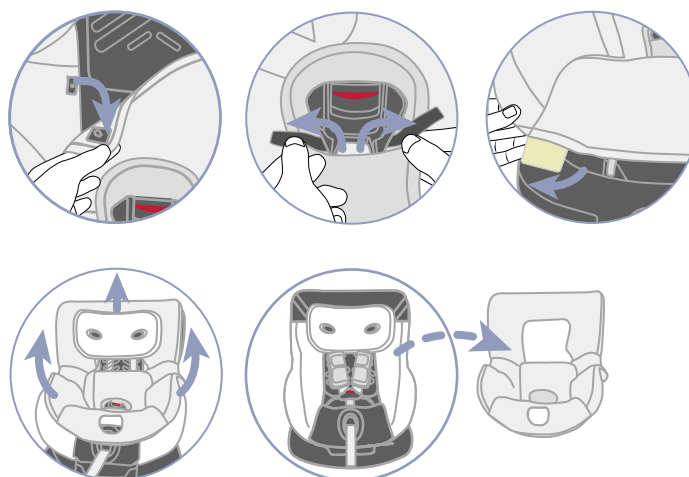
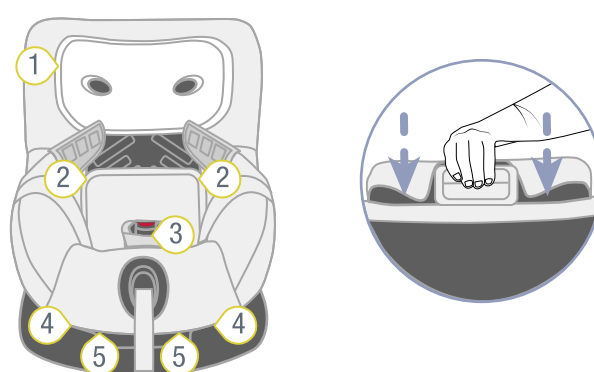

- ① headrest
- ② Pushbuttons
- ③ Velcro
- ④ Rubber loops
- ⑤ Plastic cards

1. Adjust the seat to the flattest position (see "Adjusting the seat angle", page 6).
2. Adjust the headrest 1 to the lowest position (see "Adjust headrest", page 5).
3. Open the pushbuttons 2 left and right of the rear of the cover.
4. Undo the Velcro 3 on the padded crotch.
5. In the leg area, remove the rubber loops 4 and the plastic cards 5.
6. Remove the elastic seam of the cover from the edge of the seat.
7. Thread the shoulder straps through the cutout.
8. Pull the cover from the child seat from bottom to top.

6.1.4 Clean cover

NOTE

Damage to important parts

- ▶ Before washing the seat reducer, remove all foam and styrofoam parts from the top and bottom sections.
- ▶ **Do not** wash these parts in the washing machine.

① You can remove the following covers and wash them in the washing machine:

- ▶ Cover of the seat reducer.
- ▶ Cover of the headrest.
- ▶ Seat cover.
- ▶ Cover of harness buckle.

- ▶ Note the instructions on the cover's washing label.
- ▶ Wash the cover at 30 °C with a mild detergent on the washing machine's fine wash programme.
- ▶ You can remove the shoulder pads and wash them with like warm soapy.
- ▶ You can clean the plastic parts and straps with soapy water.
- ▶ Do not use strong detergents (such as solvents).

6.1.5 Attach cover

⚠ WARNING

Risk of injury due to missing seat cover

The seat cover is an integral safety component of the child seat. If the seat cover is not used, this may lead to serious or even fatal injuries.

- ▶ Never use the child seat without the correct seat cover.
- ▶ Only use the original Britax Römer replacement seat cover.
- ▶ Replacement seat covers are available from your retailer.

- ▶ To fit the cover again, follow the steps in the reverse order.

⚠ WARNING

Risk of injury due to twisted straps.

Twisted straps have a negative impact on the protective function.

- ▶ Ensure that the straps are tight and not twisted.
- ▶ Ensure that the straps are fitted correctly in the belt slots of the cover.

6.2 Shoulder pads

6.2.1 Remove shoulder pads

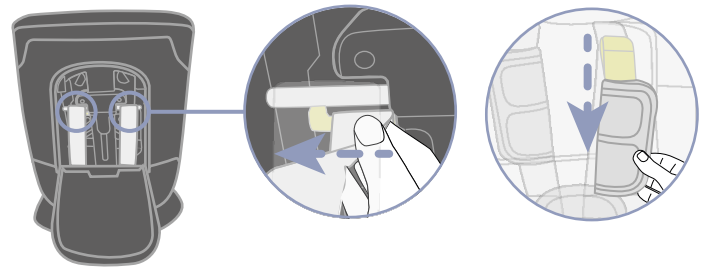
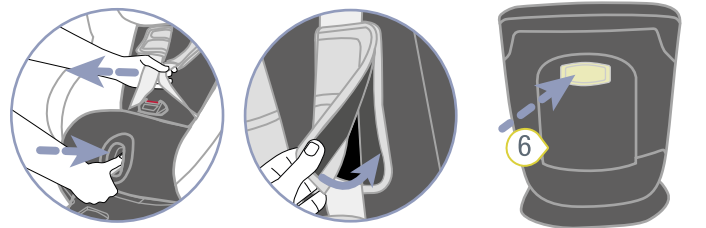
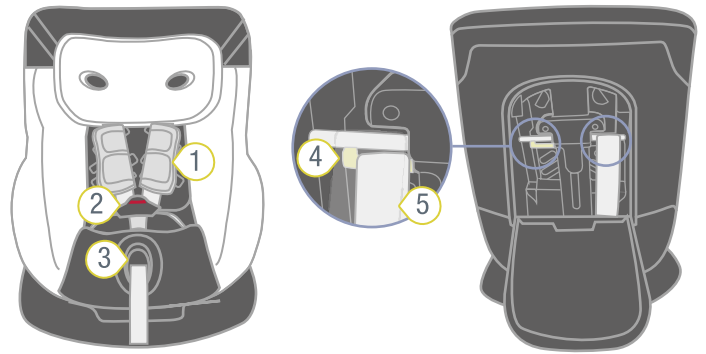

① Shoulder pads

② Shoulder strap

③ Adjustment button

④ Plastic web

⑤ End of the shoulder strap

⑥ Compartment for User Guide

1. To loosen the belt, press the adjustment button **3** and pull both shoulder straps **2** forwards at the same time.

① The shoulder pads are **not** connected to the shoulder straps. If you pull on the shoulder pads, the belt is **not** loosened. Only pull on the shoulder straps.

2. Undo the shoulder pads **1** at the Velcro on the side.
3. Rotate the seat to the rear-facing position.
4. Open the compartment for the User Guide **6**.
5. Pull the ends of the shoulder straps **5** out slightly.
6. Unhook the revealed belt loops of the shoulder pads from the plastic webs **4**.
7. Pull the shoulder pads **1** forwards out of the belt slots.

6.2.2 Attach shoulder pads

⚠ WARNING

Risk of injury due to missing shoulder pads.

The shoulder pads are an integral safety component of the child seat. If the shoulder pads are not used, this may lead to serious or even fatal injuries.

- ▶ Never use the child seat without the correct shoulder pads.
- ▶ Only use the original Britax Römer shoulder pads.

- ▶ To fit the shoulder pads again, follow the steps in the reverse order.

⚠ WARNING

Risk of injury due to twisted shoulder pads

Twisted straps have a negative impact on the protective function.

- ▶ Make sure that the shoulder pads and straps are not twisted or reversed.
- ▶ Ensure that the shoulder straps in the shoulder pads are positioned beneath the edge of the cover.

6.3 Harness buckle

6.3.1 Remove harness buckle

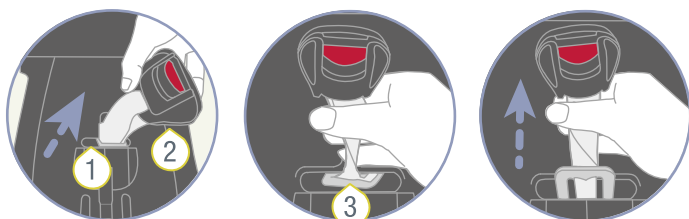

- ① Crotch strap
- ② Harness buckle
- ③ Metal plate

1. Remove the cover from the seat (see "Remove cover from the seat", page 14).
2. Use the metal plate 3 to turn the crotch strap 1 into the slot.
3. Slide the narrow edge of the metal plate 3 forwards through the belt slot.

6.3.2 Clean belt lock

1. Soak the belt lock for at least an hour. Use warm water with washing-up liquid.
2. Thoroughly rinse and dry the harness buckle.

6.3.3 Attach harness buckle

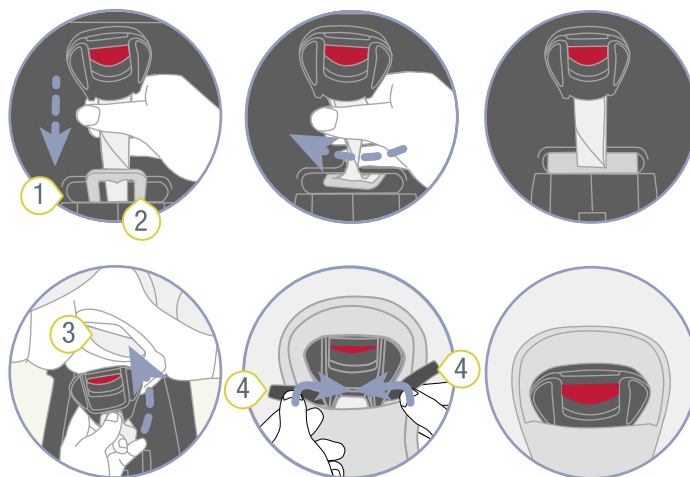

- ① Slot
- ② Metal plate
- ③ Belt slot of the cover
- ④ Velcro

1. Push the metal plate 2 completely forwards into the slot 1.
2. Turn the crotch strap with the metal plate 2 by 90° until it is hooked into the slot 1 perpendicular to the direction of travel.

⚠ **WARNING** Risk of injury from unsecured harness buckle. Make sure that the harness buckle is securely fastened to the seat by forcefully pulling at it.

3. Attach the cover again (see "Attach cover", page 15).

6.4 Troubleshooting

Harness buckle

The harness buckle is an integral part of the child seat and fulfils important functions for securing the child. Make sure that the harness buckle works perfectly.

Possible problems:

- The buckle tongues are only pushed out of slowly after pressing the red unlocking button.
- The buckle tongues no longer lock in place.
- The buckle tongues lock in place but not audibly.
- The buckle tongues can only be pushed into the harness buckle with difficulty.
- It takes a lot of force to open the harness buckle.

Solution:

- ▶ Clean the harness buckle (see "Clean belt lock", page 16).

ISOFIX connection

The ISOFIX connection is an integral part of the child seat and fulfils important functions of the child seat. Make sure that the ISOFIX connection works perfectly.

Possible problem:

- The ISOFIX locking arms of the child seat cannot be connected to the ISOFIX installation brackets of the vehicle.

Solution:

- ▶ Clean the vehicle's ISOFIX installation bracket.

7 Storage and disposal

7.1 Storage

If you do not use the product for a longer period, please note the following information.

- ▶ Store product in a secure and dry location.
- ▶ Keep the storage temperature between 20 and 25 °C.
- ▶ Do not lean heavy objects on the product.
- ▶ Do not store product directly next to sources of heat or in direct sunlight.
- ▶ Protect the product from moisture, wet conditions, liquids, dust and salt spray.

7.2 Disposal

- ▶ Do not dismantle the product.
- ▶ Prevent third parties from using the defective product.
 - ▶  Cut through the shoulder straps.
Remove the approved label.
- ▶ Please follow the disposal regulations applying in your country.

8 Contact

If there are any questions, please get in touch:

BRITAX RÖMER Child Safety EMEA

www.britax-roemer.com

contact@britax.com

BRITAX RÖMER Kindersicherheit GmbH

Theodor-Heuss-Strasse 9

89340 Leipheim

Germany